

PROFILE ORIENTATION

JOIST

FLAT SIDE UP

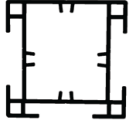

DECKING

FLAT SIDE DOWN

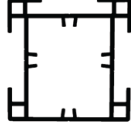

RAISED PAVER SYSTEM

BEARER

FLAT SIDE UP

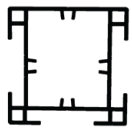

CLICKDECK PROFILES



28PROFILE

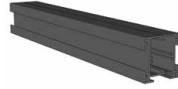

55PROFILE



110PROFILE

BASIC SPAN TABLE

Profile	Joist Span (recommended)	Bearer Span (recommended)	Cantilever (max)
28 x 50	700mm	600mm	200mm
55 x 55	1200mm	1200mm	250mm
110 x 50	1900mm	1700mm	400mm

*Please consult span tables for further information

TERMINOLOGY

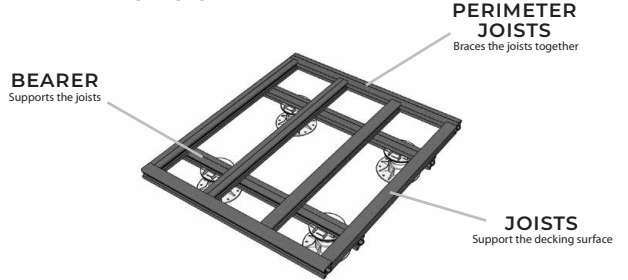

EXOLUX ADJUSTABLE PEDESTAL SYSTEM

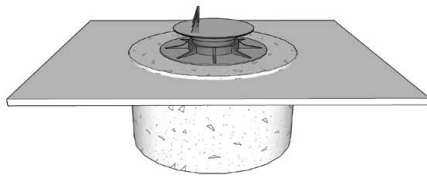

ENSURE PEDESTALS ARE SUPPORTED BY SOLID BASE

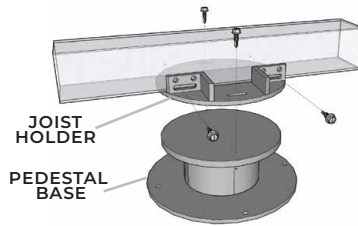

JOIST HOLDER
PEDESTAL BASE

-FASTEN DECK FRAME JOIST TO JOIST HEAD WITH 2X SCREWS

-FASTEN PLASTIC JOIST HEAD TO PEDESTAL BASE WITH 2X SCREWS

PEDESTAL HEIGHT RANGE FINISHED FLOOR HEIGHT

MODEL NO.	Height Range	Finished Floor Heights (includes 25mm deckboard + profile combination below)				
		28 JOIST ONLY	55 JOIST ONLY	55 JOIST 55 BEARER	55JOIST 110 BEARER	110 JOIST 110 BEARER
FX 0	10-25mm	63-78	90-105	145-160	200-215	255-270
PP A	24-35mm	77-88	104-115	159-170	214-225	269-280
PP B	33-47mm	86-100	113-127	168-182	223-237	278-292
PP C	45-70mm	98-123	125-150	180-205	235-260	290-315
PP D	65-110mm	118-163	145-190	200-245	255-300	310-355
PP E	95-190mm	148-243	175-270	230-325	285-380	340-435
PP E + 1 EX	185-325mm	238-378	265-405	320-460	375-515	430-570
PP E + 2 EX	260-440mm	313-493	340-520	395-575	450-630	505-685

CORNER BRACKET

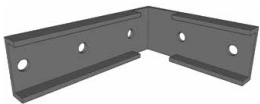

4x HEX SCREWS PER BRACKET

USING 28 OR 55PROFILE: 1 PER CONNECTION

USING 110PROFILE: 2 PER CONNECTION

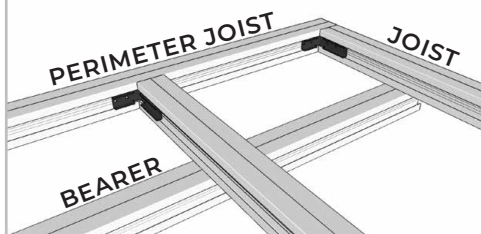

HOLD DOWN CLIP



2x SCREWS NEEDED WHEN USING WAILING PLATE

1x SCREW NEEDED IN FREESTANDING INSTALLATION

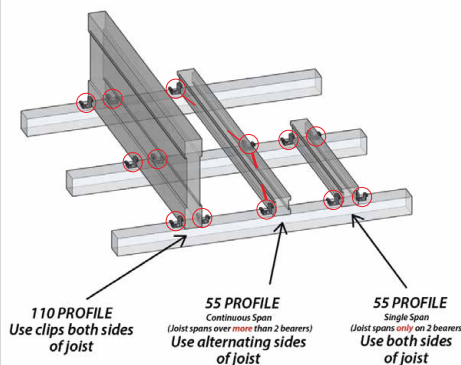

110 PROFILE Use clips both sides of joist

55 PROFILE Continuous Span (Joist spans over more than 2 bearers) Use alternating sides of joist

55 PROFILE Single Span (Joist spans only on 2 bearers) Use both sides of joist

JOINERS



4x SCREWS PER JOINER



28PROFILE 2x Needed



55PROFILE 2x Needed



110PROFILE 4x Needed

MAIN COMPONENTS - CLIP / BRACKETS

CORNER BRACKET



Pack size : 2
Used to make connections
Can be bent for angled connections

HOLD DOWN CLIP



Pack size : 25
Used to make
Joist to bearer connection

JOINERS



Pack size : 6
Used to Join
profiles together

TYPICAL LAYOUT OPTIONS

JOIST ON BEARER



JOIST ONLY BEARER

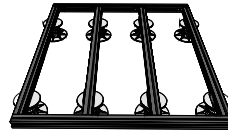

HOW TO BUILD GUIDES

Clickdeck Animation

USE THIS WEB ADDRESS:
bit.ly/3zCC8gY



Design Guide
Info@exolux.com.au

1300 921 043

CORNER BRACKET
FASTENS THE JOIST TO BEARER



JOIST SPAN

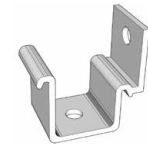

HOLD DOWN CLIP
FASTENS THE JOIST TO BEARER

JOINER
USED TO JOIN PROFILES TOGETHER
(ONLY NEEDED WHEN LONGER THAN 6M)



BEARER SPAN